

Yard



design by
Francesco Rota

[discover more](#)

Yard

Con Yard il divano diventa spazio multifunzione. Al comfort dei volumi imbottiti sono integrati piani di appoggio, mensole, contenitori a giorno per un sistema altamente personalizzabile. L'estetica è giocata sul sottile equilibrio fra le forme morbide dei grandi cuscini a parallelepipedo e la geometria sottile della struttura a vista.



With Yard the sofa becomes a multifunctional space. Supporting shelves, and open containers are integrated in the comfort of the padded volumes for a highly customizable system. The overall aesthetic effect rests on the balance between the soft shaping of the large parallelepiped cushions and the sleek lines of the exposed structure.

Biografia designer

Designer biography

Francesco Rota

Si laurea in disegno industriale all' Art Center College of Design a La Tour Peliz - Svizzera nel 1994. Apre il suo studio nel 1998 e progetta in diversi settori del mondo del design, prodotti, arredi, illuminazione, show-room, uffici, case private ed allestimenti.



Francesco Rota

Graduated in industrial design from the Art Centre College of Design at La Tour Peliz - Switzerland in 1994. He opened his own studio in 1998, where began working in different areas of the design world to include products, furniture, lighting, showrooms, offices, private homes and outfitting.

Informazioni tecniche

Technical information

1. base in metallo verniciato
2. telaio in metallo verniciato con cinghie elastiche
3. poliuretano espanso a quote differenziate
4. poliuretano espanso a quote differenziate
5. piuma d'oca canalizzata
6. inserto in metallo
7. poliuretano schiumato
8. piuma d'oca, rollofill, chips poliesteri canalizzati

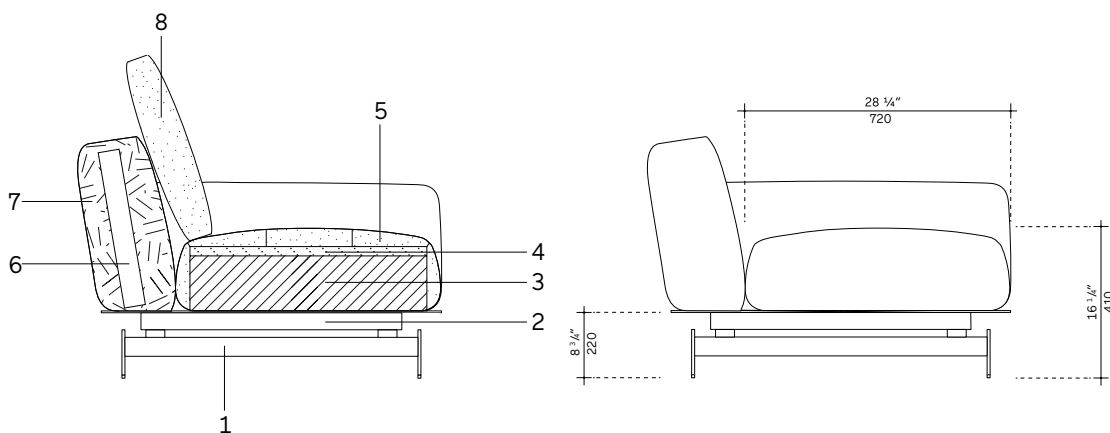

1. base in painted metal
2. frame in painted metal with elastic straps
3. polyurethane foam in differentiated densities
4. polyurethane foam in differentiated densities
5. channelled goose down
6. insert in metal
7. polyurethane foam
8. goose down, rollofill, channelled polyester chips

Struttura

Base-Braccioli-Schienali: metallo con cinghie elastiche incrociate ad alta componente di caucciù.

Imbottitura: poliuretano espanso a quote differenziate ad alta densità e resilienza.

Rivestimento: fibra termolegata accoppiato con tessuto velcrabile.

Cuscini seduta

Interno: inserto in poliuretano espanso ad alta densità e finitura della parte superiore con trapuntino in piuma d'oca canalizzata.

Piedino

Materiale: acciaio
Finitura: brunito

Sfoderabilità

Il rivestimento in tessuto della struttura è sfoderabile allentando le viti nella parte inferiore del telaio portante in metallo tramite chiave a brugola in dotazione. Il rivestimento in pelle della struttura è fisso mentre i cuscini di seduta sono sempre sfoderabili.

L'orientamento del verso del tessuto, date le molteplici varietà compositive viene definito dall'azienda.

Structure

Base-Armrests-Back: metal with high rubber content, elastic strap webbing.

Padding: high-resilience, variable density polyurethane foam.

Covering: velcro-backed, heat-bonded fibre.

Seat cushions

Inners: insert in high-density polyurethane foam with upper section in channelled goose down.

Feet

Material: steel
Finishing: burnished

Covering

The structure fabric cover can be removed by loosening the screws at the lower part of the metal frame using Allen key supplied. The leather cover of the structure is fixed, while the leather and fabric covers of the seat and back cushions are removable.

Given the variety of compositions possible, the direction of the weave is decided by Lema.

Consigli per la manutenzione e la pulizia

Care and cleaning

Per il lavaggio seguire le indicazioni specifiche per ogni variante di tessuto.

Consigli per lavaggio pelle sintetica

Spolverare delicatamente e in caso di macchie lievi passare la superficie con un panno umido o con una soluzione di detergente neutro, risciacquando con acqua, senza strizzare. Lasciare asciugare al rovescio evitando l'esposizione diretta alla luce del sole. Stirare al rovescio a bassa temperatura. Per le macchie localizzate e più ostinate (olio, grasso, cosmetici, inchiostro, caffè, liquori, chewing-gum, ecc.) si consiglia di seguire le seguenti istruzioni: disciogliere tempestivamente la macchia con alcool etilico diluito (liquido incolore) in acqua al 20%, tamponare e trattare successivamente con una soluzione di detergente neutro, risciacquare bene.

Avvertenza

I colori chiari, non devono essere messi a contatto con tessuti e capi d'abbigliamento trattati con coloranti non fissati o con scarse solidità di tintura, onde evitare macchie ed aloni di coloranti di cui non possiamo garantire la pulitura.

Come mantenere inalterata la qualità della pelle

Evitare la luce diretta del sole.

Evitare l'esposizione a fonti di calore.

Spolverare regolarmente la pelle con un panno morbido ed asciutto.

Istruzioni per pulire la pelle

Eventuali macchie si possono eliminare usando un panno inumidito con acqua e sapone neutro.

Asciugare immediatamente dopo il trattamento.

Non strofinare, ma tamponare delicatamente dai bordi al centro della macchia.

Non usare mai prodotti abrasivi o aggressivi quali solventi, smacchiatori, etc.

Non usare mai il vapore e non utilizzare i prodotti per la pulizia delle scarpe.

Per maggiore sicurezza, ogni volta che si utilizza un nuovo prodotto di pulizia, fare una prova applicandolo in una zona nascosta per verificarne l'efficacia.

Avvertenza

Evitare assolutamente prodotti a base di ammoniaca, solventi o abrasivi.

Velluto

Per ravvivare il velluto, dopo il trasporto e aver tolto l'imballo, si consiglia vivamente di vaporizzare il rivestimento senza rimuoverlo dalla struttura mantenendosi ad una distanza di circa 10 cm. Spazzolare poi la superficie del tessuto nella direzione del pelo con una spazzola a setole morbide. Se necessario ripetere l'operazione.

Parti metalliche

Usare un panno inumidito con acqua.

Sicurezza

Seguire le istruzioni di montaggio. Evitare qualsiasi modifica che possa comprometterne la stabilità.

Smaltimento

Una volta terminato l'utilizzo affidare il mobile ad aziende comunali o private preposte allo smaltimento dei rifiuti solidi ingombranti.

Follow specific instructions of each fabric for cleaning.

Synthetic leather washing instructions

Dust lightly and wipe any stains with a cloth dampened with water or a neutral soap solution, then rinse with water without squeezing. Leave to dry inside out, avoiding direct sunlight. Iron inside out at low temperature. For stubborn stains (oil, fats, make-up, ink, coffee, wine, chewing-gum, etc.), immediately apply ethyl alcohol (a colourless liquid) diluted to 20%, blot to soak up the stain, clean off using a neutral soap solution and then rinse well.

Warning

Light colours must not be mixed with fabrics and clothes that have unfixed or unstable dyes, as this may give rise to the formation of indelible stains or rings.

How to keep the leather in good condition

Avoid placing leather near direct sunlight.

Keep away from heat sources.

Dust regularly with a soft, dry cloth.

Leather cleaning instructions

Stains can be washed off using a damp cloth with mild soap.

Dry immediately after the treatment.

Do not rub. Use a circular motion working towards the centre of the stain.

Never use abrasive or aggressive products like solvents, stain removers, etc.

Never use steam or shoe cleaning products.

It is recommended that you first test clean any new cleaning product on a hidden part of the leather.

Caution

Avoid any use of products that may contain ammonia, solvents or abrasives.

Velvet

In case of pile crushing after transport, it is highly recommended to steam the cover keeping it on the frame. When steaming keep a 10 cm distance from the fabric. After steaming brush lightly the surface following the pile direction. If necessary, repeat the operation.

Metal components

Use a cloth moistened with water.

Safety

Carefully follow the assembly instructions. Do not modify the furniture in any way as this could render it unstable.

Disposal

If product needs to be disposed of, please contact the local council or a private company that can dispose of bulk waste products.

Tutti i prodotti della collezione Lema prevedono l'impiego di materiali selezionati di prima qualità. L'intero processo produttivo si avvale di tecnologie d'avanguardia, a garanzia di una elevata qualità estetica, resistenza e durata nel tempo. Le lavorazioni di finitura sono realizzate con l'ausilio di tecniche innovative e con prodotti altamente performanti, nel rispetto dei più severi protocolli internazionali e delle normative CEE / EAC in materia. In ultimo, le certificazioni UNI ISO 9001:2015 - UNI ISO 45001:2018 delineano in modo trasparente la complessa procedura gestionale dell'Azienda e del consumatore.

Rispetto per l'ambiente

Lema è molto attenta alle tematiche di ecocompatibilità, al rispetto per l'ambiente e realizza i propri prodotti garantendo al cliente finale i più elevati standard di sicurezza. Tutti i pannelli che costituiscono in larga parte "l'ossatura" del mobile sono prodotti certificati secondo le normative aziendali CARB ATCM PHASE II/U.S. EPA TSCA TITLE VI queste certificazioni normano secondo i più restrittivi protocolli internazionali il contenuto di formaldeide. L'impiego di essenze legnose è limitato alle specie di coltivazione e non vi è impiego di tipologie provenienti da deforestazione.

I materiali

Le essenze legnose, il massello, le pelli, il gres, le argille, i marmi e le pietre sono materiali che Lema tratta con la sapiente cura della più antica tradizione artigianale brianzola. Materiali di grande qualità, ulteriormente esaltati da finiture che ne mantengono inalterate le caratteristiche di origine, il colore e le sfumature. Ciò che abitualmente si chiama il "vissuto della materia", ossia tutte quelle peculiarità distintive di ogni materiale (variazioni cromatiche incontrollate, cicatrici sulla pelle ecc...), non è da considerarsi come difetto ma è testimone di un prodotto unico e di alto valore qualitativo.

Articoli in piuma e piumino d'oca e anatra

Nell'ambito del sistema produttivo ove viene utilizzata piuma e/o piumino d'oca e anatra, Lema utilizza prodotti sottoposti a regolare trattamento di bonifica igienico sanitaria (a tutela della salute pubblica e degli animali stessi) come stabilito dagli stringenti protocolli contenuti nel regolamento CE n. 1069/2009 del parlamento europeo (e relativo regolamento EU n. 142/2011).

La complessa filiera produttiva aderisce ai diversi comparti associativi che tutelano il consumatore nel rispetto per gli animali, nella tracciabilità e nella trasparenza della filiera stessa, nei processi di selezione, depolverizzazione, lavaggio, centrifugazione, essiccazione, sanitizzazione, raffreddamento del prodotto (ecc.):



Nel contesto produttivo sono categoricamente escluse pratiche come lo spiumaggio a vivo (live plucking) e l'alimentazione forzata (forced feeding), ma oltre a questo vengono mantenuti sotto controllo anche altri parametri fondamentali quali l'approvvigionamento di acqua e cibo, lo spazio disponibile e la pulizia della struttura.

Unitamente al regolamento CE, alcune ulteriori certificazioni garantiscono la corretta filiera del prodotto:



All the products of the Lema collection involve the use of selected materials of the highest quality. The entire production process uses cutting-edge technologies, which are a guarantee of their high aesthetic quality, strength and durability. The finishing processes are carried out with the help of innovative techniques and with high-performance products, in compliance with the strictest international protocols and relevant EEC / EAC regulations. Finally, the UNI ISO 9001:2015 - UNI ISO 45001:2018 certifications transparently delineate the Company's complex management procedure and respect for the consumer.

Respect for the environment

Lema is very attentive to issues of eco-compatibility and respect for the environment. Therefore, in the manufacture of its products, it guarantees the end customer the highest safety standards. All the panels, that to a large extent make up "the skeleton" of the furniture, are products certified according to the company standards CARB ATCM PHASE II/U.S. EPA TSCA TITLE VI. These certifications regulate, according to the most restrictive international protocols, the formaldehyde content. The use of wood essences is limited to cultivation species and there is no use of woods coming from deforestation.

Materials

Wood finishes, solid wood, leathers, stoneware, clays, marbles and stone - these are the materials that Lema treats with the skilful care of the most antique artisanal tradition of Brianza. Materials of great quality, further enhanced by finishes that keep their original characteristics unaltered; their colour, their gradient. All that is usually considered the "life of the materials", that is all those distinctive peculiarities of each single material (natural chromatic variations, scars in the leather ...), not to be considered as a defect but as a typical mark, in a high quality value and unique product.

Articles in feather and goose and duck down

Within the production system where feather and/or goose and duck down are used, Lema uses products subjected to regular sanitising treatments (for the protection of public health and of the animals themselves) as established by the strict protocols contained in CE Regulation no. 1069/2009 of the European Parliament (and related EU Regulation no. 142/2011).

The complex production chain adheres to the different associations of the sector that protect the consumer in regard to the treatment of the animals, the traceability and transparency of the supply chain itself, the processes of selection, dust removal, washing, centrifugation, drying, sanitisation and cooling of the product (etc.):



In the production context, practices such as live plucking and forced feeding are categorically prohibited, but in addition to this, other fundamental parameters are monitored and controlled, such as the supply of water and food, the available space and the cleaning of the structure.

Together with the EC Regulation, some further certifications guarantee the correct product supply chain:



Avvertenza

Notice

In ottemperanza alle disposizioni del Decreto Legislativo n. 206 del 6 settembre 2005 "Codice del consumo" e s.m.i.

La qualità Lema è garantita dalla produzione esclusivamente realizzata in Italia.



In compliance with the provisions of Legislative Decree N° 206 dated 06/09/2005 (Consumer Code) and subsequent amendments and additions.

The quality of Lema products is guaranteed by their being produced exclusively in Italy.

Associato a - Associated with



FEDERLEGNOARREDO

LEMA s.p.a.

22040 Alzate Brianza
Como - Italy
Strada Statale Briantea n°2
T +39 031 630 990
F +39 031 632 492

YARD

abacus components

Sofa
depth 1000 - 39 1/4"

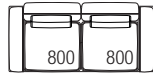

2040 - 80 1/4"

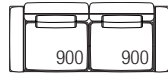

2240 - 88 1/2"

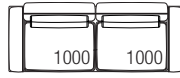

2440 - 96"



2840 - 111 3/4"

Sofa
depth 1000 - 39 1/4"

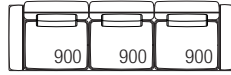

3140 - 123 1/2"

Sofa
depth 1000 - 39 1/4"

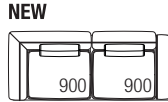

2340 - 92"

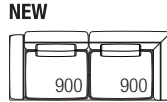

2340 - 92"



3240 - 127 1/2"



3240 - 127 1/2"

End unit
depth 1000 - 39 1/4"



LH
1820 - 71 3/4"

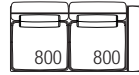

RH

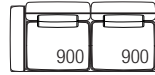

LH
2020 - 79 1/2"



RH

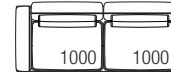

LH
2220 - 87 1/2"

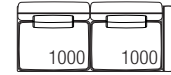

RH



LH
2920 - 115"



RH



LH
2920 - 115"



RH

Central unit
depth 1000 - 39 1/4"



1600 - 63"



1800 - 70 3/4"



2000 - 78 3/4"



2700 - 106 1/2"

Corner unit
depth 1000 - 39 1/4"



LH
2120 - 83 1/2"



RH

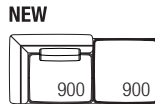

LH
2120 - 83 1/2"

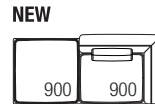

RH



LH
3020 - 119"



RH



LH
3020 - 119"



RH

Dormeuse
depth 1600 - 63"

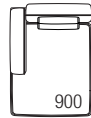

LH
1120 - 44"

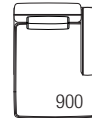

RH

YARD

abacus components

Elemento penisola prof. 1000 - 39 1/4"

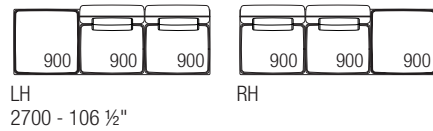
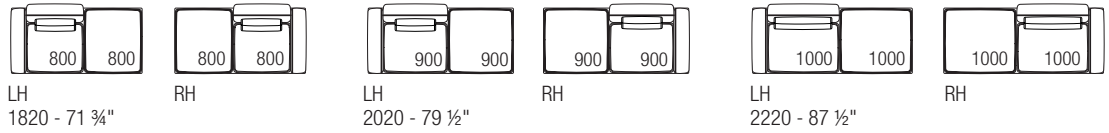
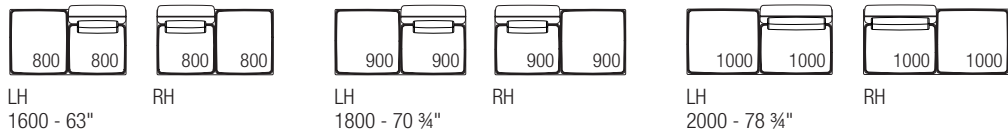

End unit with space arranged for code RP090 depth 1000 - 39 1/4"

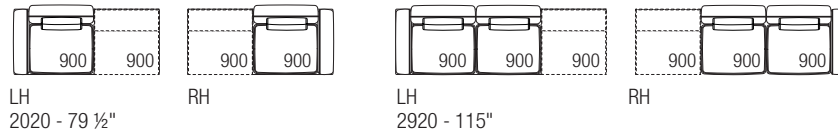

Central unit with space arranged for code RP090 depth 1000 - 39 1/4"

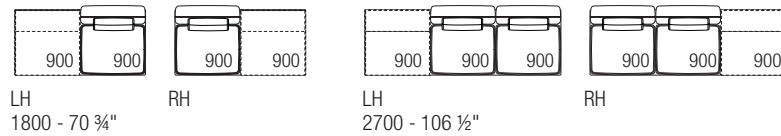

Corner unit with space arranged for code RP090 depth 1000 - 39 1/4"

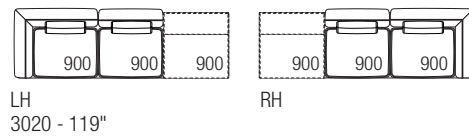

Yard daybed depth 910 - 35 3/4"

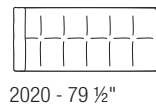

Unit with drawer and open container RP090 depth 900 - 35 1/4"

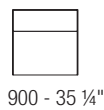

Additional cushion

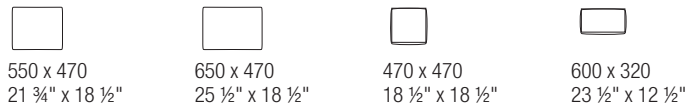

Yard sofa shelf

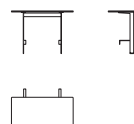

Open container Yard retro sofa

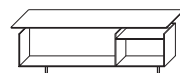

Court Yard coffee table



YARD

accessories to fasten to the structure and daybed

Accessories to fasten to the structure

shelf

mm 810 - 7" x 500 - 19 ¾" x h. 455 - 18"
heat-treated oak top

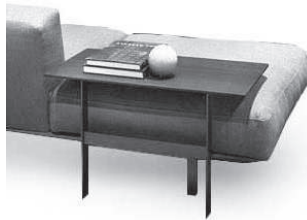
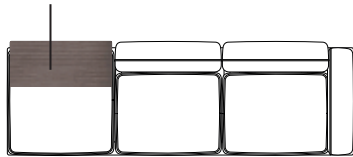

unit with drawer and open compartment

mm 900 - 35 ½" x 900 - 35 ½" x h. 171 - 6 ¾"
matt grey stone top

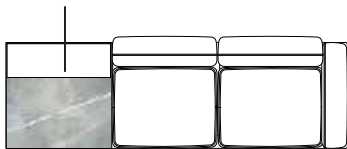

retro sofa open unit

mm 1710 - 67 ¼" x 410 - 16 ¼" x h. 670 - 26 ¾"
top and container in heat-treated oak



Daybed



mm 2020 - 79 ½" x 910 - 35 ½" x h. 335 - 13 ¼"
with roll pillow