

PAPER TABLE Ø42 LOUNGE TABLE //3-LEGS WOODEN BASE

GAMFRATESI COLLECTION

Designed by GamFratesi

PRODUCT



Item no.: 10020FH-Ø42-xx + style code
 Oak: 10020FH-Ø42-04
 Walnut: 10020FH-Ø42-07



COLORS

Tabletop



// Oak nature



// Walnut nature

DESCRIPTION

The tables in the Paper Table consists of 3 round tables in veneer. Available in 3 heights and diameters: High: height 50 cm and a diameter of 42 cm, Medium: height 40cm and a diameter of 60 cm and Low: height 33 cm and a diameter of 80 cm. The tables have wooden base with 3 equal legs. The table top is in laminated oak veneer surface applied to an MDF board. The veneer is in 2 directions and the colour is in oak nature. Edges of tabletop and base are in same sort of veneer and wood and in the same color. The thickness of the table top is 20 mm

VERSION - VENEER

- Oak nature / Oak nature base // Gloss level 20-30 / Gloss level 20-30
- Walnut nature / Walnut nature base // Gloss level 20-30 / Gloss level 20-30

TABLE VERSIONS

Order item - look for part number in the pricelist.

The series consists of the following:

PAPER TABLE - High Ø42 cm, Medium Ø60 cm, Low Ø80 cm

FACTS

MEASUREMENT - L x W x H mm

Table height: 500 mm
 Table top diameter: Ø420 mm
 Table top thickness: 20 mm
 Base height: 480 mm
 Leg thickness: 25 - 30 mm
 Leg width: 60 mm

WEIGHT ITEM
 3,6 kg

PACKAGING TYPE
 Cardboard box

PACKAGING MEASUREMENT - L x W x H cm
 L: 48 x W: 49 x H: 10,5 cm

WEIGHT PACKAGING - MATERIAL TYPE
 Will be updated as soon as possible

WEIGHT PACKAGING - TOTAL
 4,2 kg

NUMBER OF PARCELS
 1 pcs.

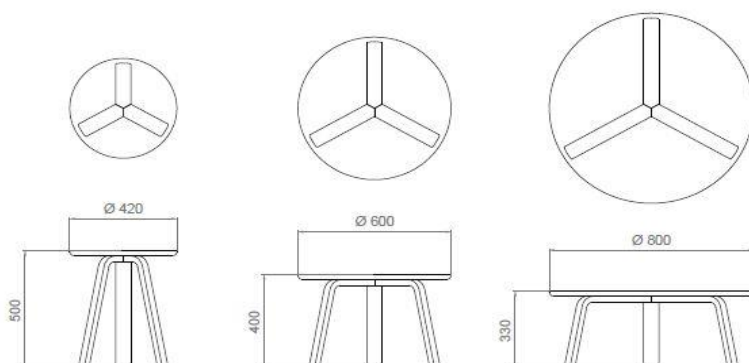

Designed by GamFratesi

ACCESSORIES

-

CLEANING AND MAINTENANCE

For dusting and light cleaning of the wooden surface and frame use a soft, dry cloth.

For further cleaning, use a soft cloth that is firmly wrung in clean water for gently wiping the surface, and then immediately use a dry cloth to wipe the surface again.

If more thorough cleaning is necessary, use a mild detergent or washing-up liquid dissolved in water on a firmly wrung cloth. Afterwards, repeat the process with clean water as described above.

Polish with a soft cloth after wiping.

Do not use materials for maintenance that:

- Contain abrasive agents.
- Are basic, acidiferous or organic.

For the best maintenance of the product, protect it against sunlight and heat, and try to keep it away from moisture, grease and other dirt.

Furthermore, protect the surfaces against sharp objects and other that might scratch.

ENVIRONMENT

Parts can be separated and sorted for recycling.

TESTS

-

CERTIFICATION AND LABELS

-